

# DATASHEET

## R-6LP-G1H-28D-A1

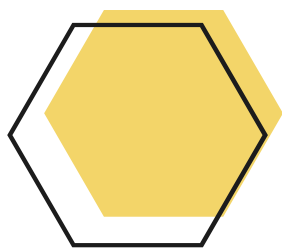

### Wi-SUN Transceiver

High-Performance, Wi-SUN Transceiver Module built around Renesas RL78-G1H Chipset

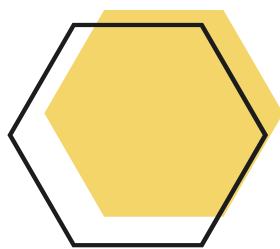

### Sub GHz ISM Band

863 MHz to 928 MHz operating Frequency in license-free Band

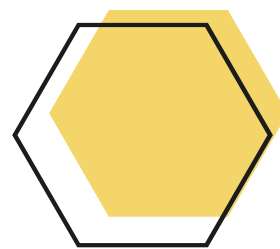

### Industrial grade

-40 deg C to +85 deg C operation temperature

dun & bradstreet



#### VIZMONET PTE LTD

21 Woodlands Close, #03-01, Primz Biz Hub, Singapore 737 854  
+65 6255 0581 | enquiry@vizmonet.com | www.vizmonet.com

## TECHNICAL SPECIFICATION

RADIO MODULE – GENERAL INFO	
Chipset Info	Renesas RL78/G1H, 16 bit MCU, 32 MHz, 44 DMIPS
Memory (Max Option)	Program Flash 512 KB, Data flash 8 KB, SRAM 48 KB
Operating Frequency	863 MHz to 928 MHz
Data Modulation	2GFSK/4GFSK
Operating Mode	Fixed Frequency mode & Frequency Hopping (SW Configurable)
Number of Channels (50 Kbps)	EU-69, NA-129, JP-38, IN-19
Number of Channels (100 Kbps)	EU-35, JP-37, IN-10
Number of Channels (150 Kbps)	EU-35, NA-64
Number of Channels (200 Kbps)	NA-64, JP-36
RoHS Compliance	Compliant
INTERFACE SPECIFICATIONS	
Interface	UART Interface, 115,200 baud, Berg Stick Connectors, 2.0 mm Pitch
Operating Voltage	3.3V +/- 10%
Stand by Current in RX Mode	6 mA
RF Antenna	Integrated Chip Antenna
ENVIRONMENTAL SPECIFICATIONS	
Operating Temperature Range	-40 deg C to +85 deg C
PHYSICAL SPECIFICATIONS	
Mechanical Dimension (Assembled condition)	(L) 25 mm x (W) 53 mm x (H) 9.1 mm
Weight of the Module without ESD Bag	6 g
REGULATORY INFORMATION	
Compliance	TBD  Regions Supported – USA, CANADA, EUROPE, JAPAN, INDIA  Please contact <a href="mailto:enquiry@vizmonet.com">enquiry@vizmonet.com</a> for any other regions not listed here.
PACKAGING INFORMATION	
No of units - TBD	Carton Size - TBD

ORDERING INFORMATION

R-6LP-G1H-28D-A1	RF Transceiver Module, 6LoWPAN, 863 to 928 MHz, Internal Antenna, 28 dBm
------------------	--

## RADIO SPECIFICATION

### TX Power and RX Sensitivity

902 MHz to 928 MHz, +/-1 dBm

TX Power Setting	Power (dBm)	Current at 3.3V (mA)
1	8.5	80
5	11	90
10	13.5	110
20	16	120
30	19	140
40	21	190
50	24	260
60	26	290
70	27	320
80	28	350

902 MHz to 928 MHz, BER <1%, +/-1 dBm

Data Rate (Kbps)	Modulation	RX Sensitivity (dBm)
50	2GFSK	-113
100	2GFSK	-111
150	2GFSK	-109
200	2GFSK	-108

### Connector Pin layout

Pin Number	Function	Pin Number	Function
1	VDD	20	TOOLO (P40)
2	TXD (P02)	19	LED1 (P60)
3	RXD (P03)	18	LED1 (P61)
4	NC	17	LED1 (P62)
5	RESET	16	RXD3(P143)
6	ANI12(P156)	15	TXD3(P144)
7	ANI13(P155)	14	SCK30(P142)
8	ANI14(P22)	13	SCK21(P70)
9	INTPO(P137)	12	SI71(P71)
10	GND	11	SO21(P72)

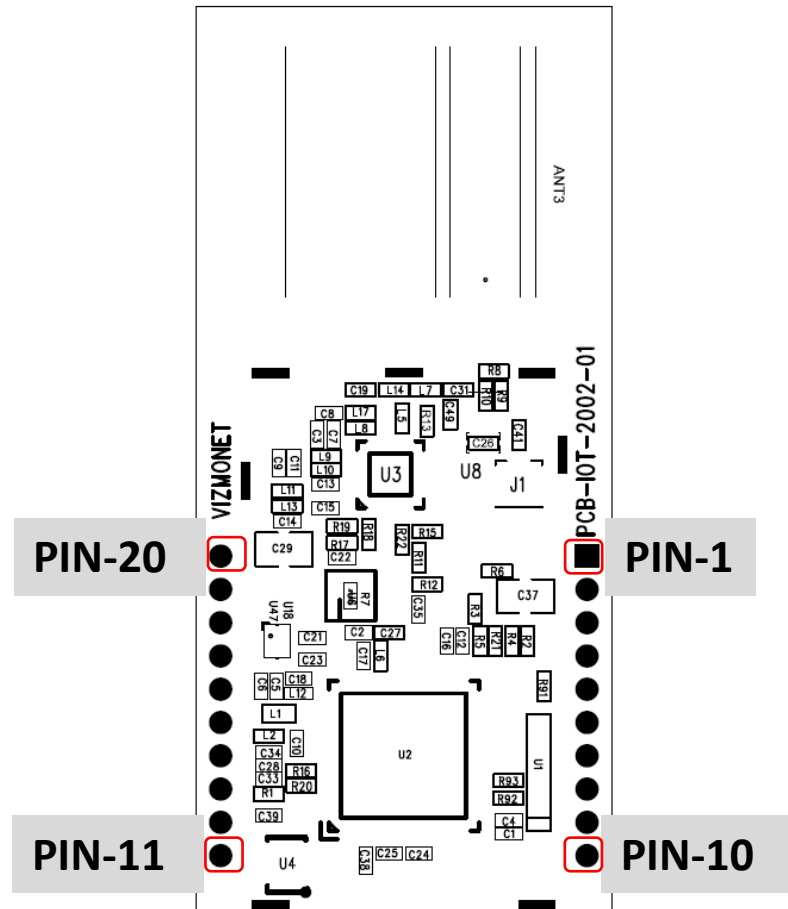

## Connector Pin Description

Pin No	Pin Name	Description
1	VDD	Module Power supply input, 3.3V +/- 10 %
2	TXD (P02)	UART OUT (TX), connected to Port P02 of R7L78/G1H
3	RXD (P03)	UART OUT (RX), connected to Port P03 of RL78/G1H
5	RESET	Reset input
10	GND	GND
20	TOOL0(P40)	Data Input / Output for Renesas Programming Tool

## Fan-out GPIO

Pin No	Pin Name	Description
6	ANI12(P156)	ADC Input connected to Port P156 of RL78/G1H
7	ANI13(P155)	ADC Input connected to Port P155 of RL78/G1H
8	ANI14(P22)	ADC Input connected to Port P22 of RL78/G1H
9	INTP0(P137)	External Interrupt input connected to Port P137 of RL78/G1H
11	SO21(P72)	GPIO connected to Port P72 of RL78/G1H, can be used for Serial data I/O
12	SI71(P71)	GPIO connected to Port P71 of RL78/G1H, can be used for Serial data I/O
13	SCK21(P70)	GPIO connected to Port P70 of RL78/G1H, can be used for Serial data I/O
14	SCK30(P142)	GPIO connected to Port P142 of RL78/G1H, can be used for Serial data I/O
15	TXD3(P144)	GPIO connected to Port P144 of RL78/G1H, can be used for additional UART
16	RXD3(P143)	GPIO connected to Port P143 of RL78/G1H, can be used for additional UART
17	LED1 (P62)	GPIO Connected to Port P60 of RL78/G1H. It can be connected to LED (Active Low) in Base Board for Wi-SUN Status
18	LED1 (P61)	GPIO Connected to Port P60 of RL78/G1H. It can be connected to LED (Active Low) in Base Board for Wi-SUN Status
19	LED1 (P60)	GPIO Connected to Port P60 of RL78/G1H. It can be connected to LED (Active Low) in Base Board for Wi-SUN Status

Fan-out GPIO must be NC, when not used in the Target Board, where the module is mounted

**Supported Frequency Bands and Channel Wi-SUN Parameters**

NA- North America that includes USA & CANADA								
Frequency (MHz)	Region	Wi-SUN PHY Mode	G1H Band ID	Data Rate (Kbps)	Modulation	Modulation Index	No of Channels	Channel Spacing (KHz)
863-870	Europe	0	4	50	2GFSK	0.5	69	100
863-870	Europe	1	4	100	2GFSK	0.5	35	200
863-870	Europe	2	4	150	2GFSK	0.5	35	200
902-928	NA	3	7	50	2GFSK	1	129	200
902-928	NA	4	7	150	2GFSK	0.5	64	400
902-928	NA	5	7	200	2GFSK	0.5	64	400
920-928	Japan	8	9	50	2GFSK	1	38	200
920-928	Japan	9	9	100	2GFSK	1	37	200
920-928	Japan	11	9	200	2GFSK	1	36	200
865-867	India	13	4	50	2GFSK	0.5	19	100
865-867	India	14	4	100	2GFSK	0.5	10	200

### Frequency Channel Mapping

(Europe) Band ID 4, Channel setting of the Wi-SUN PHY Mode 0, 50 Kbps

Channel number	Frequency (MHz)	Channel number	Frequency (MHz)	Channel number	Frequency (MHz)	Channel number	Frequency (MHz)
0 (0x00)	863.1	1 (0x01)	863.2	2 (0x02)	863.3	3 (0x03)	863.4
4 (0x04)	863.5	5 (0x05)	863.6	6 (0x06)	863.7	7 (0x07)	863.8
8 (0x08)	863.9	9 (0x09)	864	10 (0xA)	864.1	11 (0xB)	864.2
12 (0xC)	864.3	13 (0xD)	864.4	14 (0xE)	864.5	15 (0xF)	864.6
16 (0x10)	864.7	17 (0x11)	864.8	18 (0x12)	864.9	19 (0x13)	865
20 (0x14)	865.1	21 (0x15)	865.2	22 (0x16)	865.3	23 (0x17)	865.4
24 (0x18)	865.5	25 (0x19)	865.6	26 (0x1A)	865.7	27 (0x1B)	865.8
28 (0x1C)	865.9	29 (0x1D)	866	30 (0x1E)	866.1	31 (0x1F)	866.2
32 (0x20)	866.3	33 (0x21)	866.4	34 (0x22)	866.5	35 (0x23)	866.6
36 (0x24)	866.7	37 (0x25)	866.8	38 (0x26)	866.9	39 (0x27)	867
40 (0x28)	867.1	41 (0x29)	867.2	42 (0x2A)	867.3	43 (0x2B)	867.4
44 (0x2C)	867.5	45 (0x2D)	867.6	46 (0x2E)	867.7	47 (0x2F)	867.8
48 (0x30)	867.9	49 (0x31)	868	50 (0x32)	868.1	51 (0x33)	868.2
52 (0x34)	868.3	53 (0x35)	868.4	54 (0x36)	868.5	55 (0x37)	868.6
56 (0x38)	868.7	57 (0x39)	868.8	58 (0x3A)	868.9	59 (0x3B)	869
60 (0x3C)	869.1	61 (0x3D)	869.2	62 (0x3E)	869.3	63 (0x3F)	869.4
64 (0x40)	869.5	65 (0x41)	869.6	66 (0x42)	869.7	67 (0x43)	869.8
68 (0x44)	869.9						

(Europe) Band ID 4, Channel setting of the Wi-SUN PHY Mode 0, 50 Kbps

Channel number	Frequency (MHz)	Channel number	Frequency (MHz)	Channel number	Frequency (MHz)	Channel number	Frequency (MHz)
0 (0x00)	863.1	1 (0x01)	863.3	2 (0x02)	863.5	3 (0x03)	863.7
4 (0x04)	863.9	5 (0x05)	864.1	6 (0x06)	864.3	7 (0x07)	864.5
8 (0x08)	864.7	9 (0x09)	864.9	10 (0xA)	865.1	11 (0xB)	865.3
12 (0xC)	865.5	13 (0xD)	865.7	14 (0xE)	865.9	15 (0xF)	866.1
16 (0x10)	866.3	17 (0x11)	866.5	18 (0x12)	866.7	19 (0x13)	866.9
20 (0x14)	867.1	21 (0x15)	867.3	22 (0x16)	867.5	23 (0x17)	867.7
24 (0x18)	867.9	25 (0x19)	868.1	26 (0x1A)	868.3	27 (0x1B)	868.5
28 (0x1C)	868.7	29 (0x1D)	868.9	30 (0x1E)	869.1	31 (0x1F)	869.3
32 (0x20)	869.5	33 (0x21)	869.7	34 (0x22)	869.9		

(North America) Band ID 7, Channel setting of the Wi-SUN PHY Mode 3, 50 Kbps

Channel number	Frequency (MHz)	Channel number	Frequency (MHz)	Channel number	Frequency (MHz)	Channel number	Frequency (MHz)
0 (0x00)	902.2	1 (0x01)	902.4	2 (0x02)	902.6	3 (0x03)	902.8
4 (0x04)	903	5 (0x05)	903.2	6 (0x06)	903.4	7 (0x07)	903.6
8 (0x08)	903.8	9 (0x09)	904	10 (0x0A)	904.2	11 (0x0B)	904.4
12 (0x0C)	904.6	13 (0x0D)	904.8	14 (0x0E)	905	15 (0x0F)	905.2
16 (0x10)	905.4	17 (0x11)	905.6	18 (0x12)	905.8	19 (0x13)	906
20 (0x14)	906.2	21 (0x15)	906.4	22 (0x16)	906.6	23 (0x17)	906.8
24 (0x18)	907	25 (0x19)	907.2	26 (0x1A)	907.4	27 (0x1B)	907.6
28 (0x1C)	907.8	29 (0x1D)	908	30 (0x1E)	908.2	31 (0x1F)	908.4
32 (0x20)	908.6	33 (0x21)	908.8	34 (0x22)	909	35 (0x23)	909.2
36 (0x24)	909.4	37 (0x25)	909.6	38 (0x26)	909.8	39 (0x27)	910
40 (0x28)	910.2	41 (0x29)	910.4	42 (0x2A)	910.6	43 (0x2B)	910.8
44 (0x2C)	911	45 (0x2D)	911.2	46 (0x2E)	911.4	47 (0x2F)	911.6
48 (0x30)	911.8	49 (0x31)	912	50 (0x32)	912.2	51 (0x33)	912.4
52 (0x34)	912.6	53 (0x35)	912.8	54 (0x36)	913	55 (0x37)	913.2
56 (0x38)	913.4	57 (0x39)	913.6	58 (0x3A)	913.8	59 (0x3B)	914
60 (0x3C)	914.2	61 (0x3D)	914.4	62 (0x3E)	914.6	63 (0x3F)	914.8
64 (0x40)	915	65 (0x41)	915.2	66 (0x42)	915.4	67 (0x43)	915.6
68 (0x44)	915.8	69 (0x45)	916	70 (0x46)	916.2	71 (0x47)	916.4
72 (0x48)	916.6	73 (0x49)	916.8	74 (0x4A)	917	75 (0x4B)	917.2
76 (0x4C)	917.4	77 (0x4D)	917.6	78 (0x4E)	917.8	79 (0x4F)	918
80 (0x50)	918.2	81 (0x51)	918.4	82 (0x52)	918.6	83 (0x53)	918.8
84 (0x54)	919	85 (0x55)	919.2	86 (0x56)	919.4	87 (0x57)	919.6
88 (0x58)	919.8	89 (0x59)	920	90 (0x5A)	920.2	91 (0x5B)	920.4
92 (0x5C)	920.6	93 (0x5D)	920.8	94 (0x5E)	921	95 (0x5F)	921.2
96 (0x60)	921.4	97 (0x61)	921.6	98 (0x62)	921.8	99 (0x63)	922
100(0x64)	922.2	101(0x65)	922.4	102(0x66)	922.6	103(0x67)	922.8
104(0x68)	923	105(0x69)	923.2	106(0x6A)	923.4	107(0x6B)	923.6
108(0x6C)	923.8	109(0x6D)	924	110(0x6E)	924.2	111(0x6F)	924.4
112(0x70)	924.6	113(0x71)	924.8	114(0x72)	925	115(0x73)	925.2
116(0x74)	925.4	117(0x75)	925.6	118(0x76)	925.8	119(0x77)	926
120(0x78)	926.2	121(0x79)	926.4	122(0x7A)	926.6	123(0x7B)	926.8
124(0x7C)	927	125(0x7D)	927.2	126(0x7E)	927.4	127(0x7F)	927.6
128(0x80)	927.8						

(North America) Band ID 7, Channel setting of the Wi-SUN PHY Mode 4, 150 Kbps, PHY Mode 5, 200 Kbps

Channel number	Frequency (MHz)	Channel number	Frequency (MHz)	Channel number	Frequency (MHz)	Channel number	Frequency (MHz)
0 (0x00)	902.4	1 (0x01)	902.8	2 (0x02)	903.2	3 (0x03)	903.6
4 (0x04)	904	5 (0x05)	904.4	6 (0x06)	904.8	7 (0x07)	905.2
8 (0x08)	905.6	9 (0x09)	906	10 (0x0A)	906.4	11 (0x0B)	906.8
12 (0x0C)	907.2	13 (0x0D)	907.6	14 (0x0E)	908	15 (0x0F)	908.4
16 (0x10)	908.8	17 (0x11)	909.2	18 (0x12)	909.6	19 (0x13)	910
20 (0x14)	910.4	21 (0x15)	910.8	22 (0x16)	911.2	23 (0x17)	911.6
24 (0x18)	912	25 (0x19)	912.4	26 (0x1A)	912.8	27 (0x1B)	913.2
28 (0x1C)	913.6	29 (0x1D)	914	30 (0x1E)	914.4	31 (0x1F)	914.8
32 (0x20)	915.2	33 (0x21)	915.6	34 (0x22)	916	35 (0x23)	916.4
36 (0x24)	916.8	37 (0x25)	917.2	38 (0x26)	917.6	39 (0x27)	918
40 (0x28)	918.4	41 (0x29)	918.8	42 (0x2A)	919.2	43 (0x2B)	919.6
44 (0x2C)	920	45 (0x2D)	920.4	46 (0x2E)	920.8	47 (0x2F)	921.2
48 (0x30)	921.6	49 (0x31)	922	50 (0x32)	922.4	51 (0x33)	922.8
52 (0x34)	923.2	53 (0x35)	923.6	54 (0x36)	924	55 (0x37)	924.4
56 (0x38)	924.8	57 (0x39)	925.2	58 (0x3A)	925.6	59 (0x3B)	926
60 (0x3C)	926.4	61 (0x3D)	926.8	62 (0x3E)	927.2	63 (0x3F)	927.6

(Japan) Band ID 9, Channel setting of the Wi-SUN PHY Mode 8, 50 Kbps

Channel number	Frequency (MHz)	Channel number	Frequency (MHz)	Channel number	Frequency (MHz)	Channel number	Frequency (MHz)
0 (0x00)	920.6	1 (0x01)	920.8	2 (0x02)	921	3 (0x03)	921.2
4 (0x04)	921.4	5 (0x05)	921.6	6 (0x06)	921.8	7 (0x07)	922
8 (0x08)	922.2	9 (0x09)	922.4	10 (0x0A)	922.6	11 (0x0B)	922.8
12 (0x0C)	923	13 (0x0D)	923.2	14 (0x0E)	923.4	15 (0x0F)	923.6
16 (0x10)	923.8	17 (0x11)	924	18 (0x12)	924.2	19 (0x13)	924.4
20 (0x14)	924.6	21 (0x15)	924.8	22 (0x16)	925	23 (0x17)	925.2
24 (0x18)	925.4	25 (0x19)	925.6	26 (0x1A)	925.8	27 (0x1B)	926
28 (0x1C)	926.2	29 (0x1D)	926.4	30 (0x1E)	926.6	31 (0x1F)	926.8
32 (0x20)	927	33 (0x21)	927.2	34 (0x22)	927.4	35 (0x23)	927.6
36 (0x24)	927.8	37 (0x25)	928				



(Japan) Band ID 9, Channel setting of the Wi-SUN PHY Mode 9, 100 Kbps

Channel number	Frequency (MHz)	Channel number	Frequency (MHz)	Channel number	Frequency (MHz)	Channel number	Frequency (MHz)
0 (0x00)	920.7	1 (0x01)	920.9	2 (0x02)	921.1	3 (0x03)	921.3
4 (0x04)	921.5	5 (0x05)	921.7	6 (0x06)	921.9	7 (0x07)	922.1
8 (0x08)	922.3	9 (0x09)	922.5	10 (0x0A)	922.7	11 (0x0B)	922.9
12 (0x0C)	923.1	13 (0x0D)	923.3	14 (0x0E)	923.5	15 (0x0F)	923.7
16 (0x10)	923.9	17 (0x11)	924.1	18 (0x12)	924.3	19 (0x13)	924.5
20 (0x14)	924.7	21 (0x15)	924.9	22 (0x16)	925.1	23 (0x17)	925.3
24 (0x18)	925.5	25 (0x19)	925.7	26 (0x1A)	925.9	27 (0x1B)	926.1
28 (0x1C)	926.3	29 (0x1D)	926.5	30 (0x1E)	926.7	31 (0x1F)	926.9
32 (0x20)	927.1	33 (0x21)	927.3	34 (0x22)	927.5	35 (0x23)	927.7
36 (0x24)	927.9						

(Japan) Band ID 9, Channel setting of the Wi-SUN PHY Mode 11, 200 Kbps

Channel number	Frequency (MHz)	Channel number	Frequency (MHz)	Channel number	Frequency (MHz)	Channel number	Frequency (MHz)
0 (0x00)	920.8	1 (0x01)	921	2 (0x02)	921.2	3 (0x03)	921.4
4 (0x04)	921.6	5 (0x05)	921.8	6 (0x06)	922	7 (0x07)	922.2
8 (0x08)	922.4	9 (0x09)	922.6	10 (0x0A)	922.8	11 (0x0B)	923
12 (0x0C)	923.2	13 (0x0D)	923.4	14 (0x0E)	923.6	15 (0x0F)	923.8
16 (0x10)	924	17 (0x11)	924.2	18 (0x12)	924.4	19 (0x13)	924.6
20 (0x14)	924.8	21 (0x15)	925	22 (0x16)	925.2	23 (0x17)	925.4
24 (0x18)	925.6	25 (0x19)	925.8	26 (0x1A)	926	27 (0x1B)	926.2
28 (0x1C)	926.4	29 (0x1D)	926.6	30 (0x1E)	926.8	31 (0x1F)	927
32 (0x20)	927.2	33 (0x21)	927.4	34 (0x22)	927.6	35 (0x23)	927.8

(India) Band ID 4, Channel setting of the Wi-SUN PHY Mode 13, 50 Kbps

Channel number	Frequency (MHz)	Channel number	Frequency (MHz)	Channel number	Frequency (MHz)	Channel number	Frequency (MHz)
20 (0x14)	865.1	21 (0x15)	865.2	22 (0x16)	865.3	23 (0x17)	865.4
24 (0x18)	865.5	25 (0x19)	865.6	26 (0x1A)	865.7	27 (0x1B)	865.8
28 (0x1C)	865.9	29 (0x1D)	866	30 (0x1E)	866.1	31 (0x1F)	866.2
32 (0x20)	866.3	33 (0x21)	866.4	34 (0x22)	866.5	35 (0x23)	866.6
36 (0x24)	866.7	37 (0x25)	866.8	38 (0x26)	866.9		

(India) Band ID 4, Channel setting of the Wi-SUN PHY Mode 14, 100 Kbps

Channel number	Frequency (MHz)	Channel number	Frequency (MHz)	Channel number	Frequency (MHz)	Channel number	Frequency (MHz)
					865.1	11 (0xB)	865.3
12 (0xC)	865.5	13 (0xD)	865.7	14 (0xE)	865.9	15 (0xF)	866.1
16 (0x10)	866.3	17 (0x11)	866.5	18 (0x12)	866.7	19 (0x13)	866.9

### ANTENNA PERFORMANCE SPECIFICATION

**Gain Vs Frequency**

Freq. [MHz]	Peak Gain (dBi)	Avg. Gain (dBi)	Efficiency(%)
902	1.1	-2.9	51
915	1.3	-2.7	54
928	0.9	-3.4	46

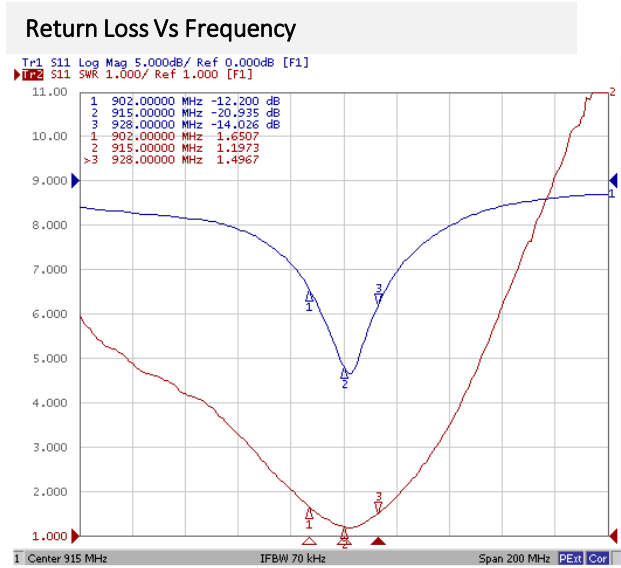

**3D Radiation Pattern**

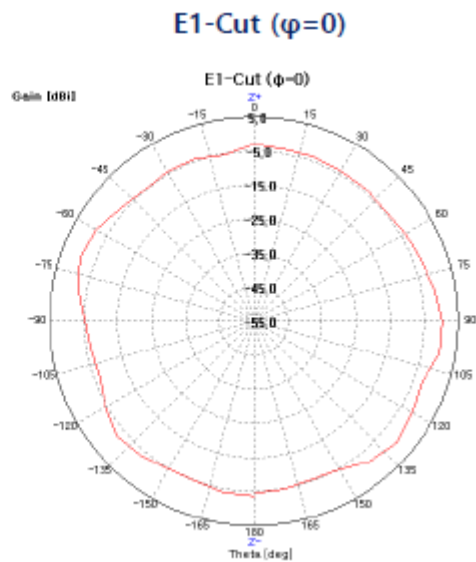
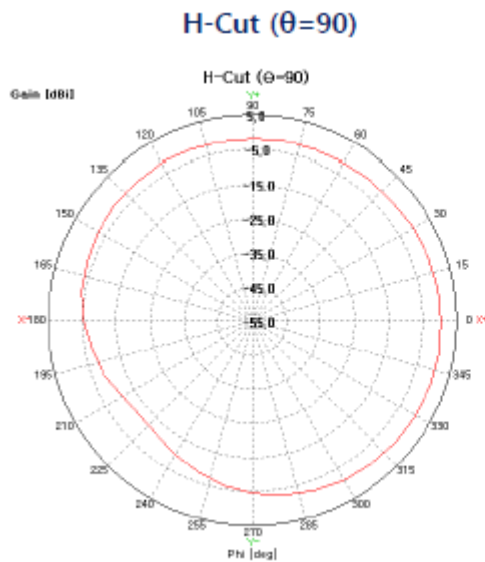
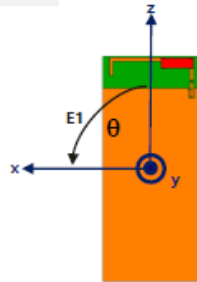

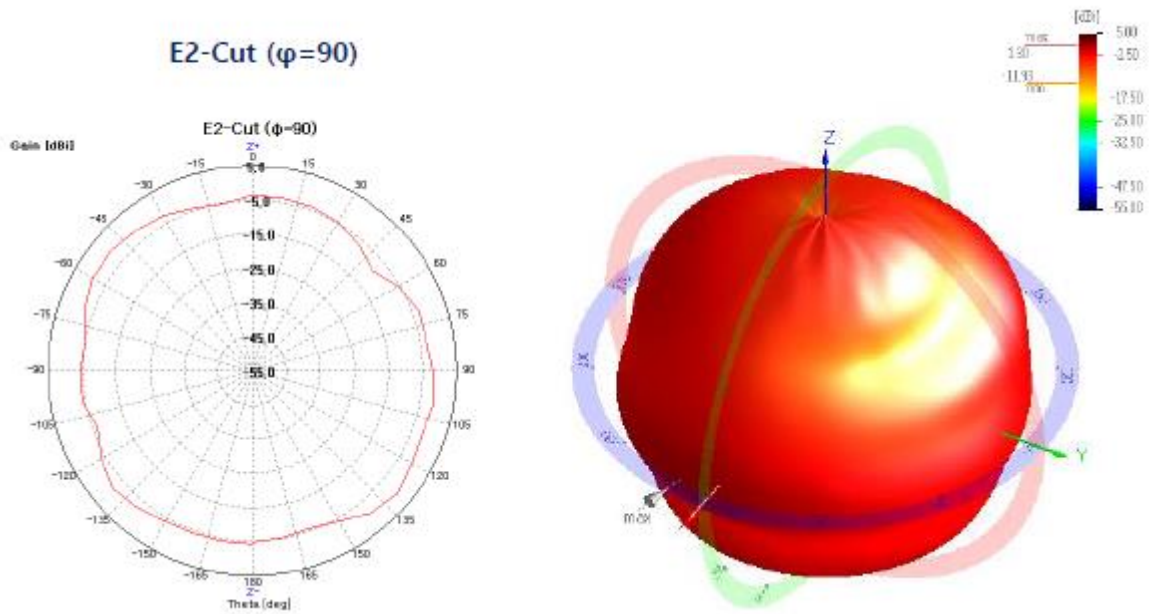

## MECHANICAL DIMENSIONS

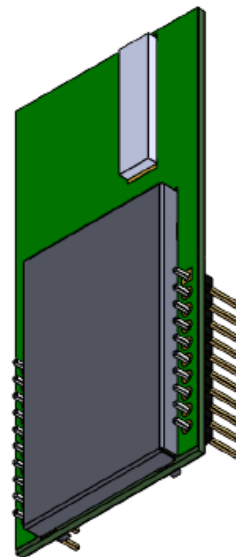
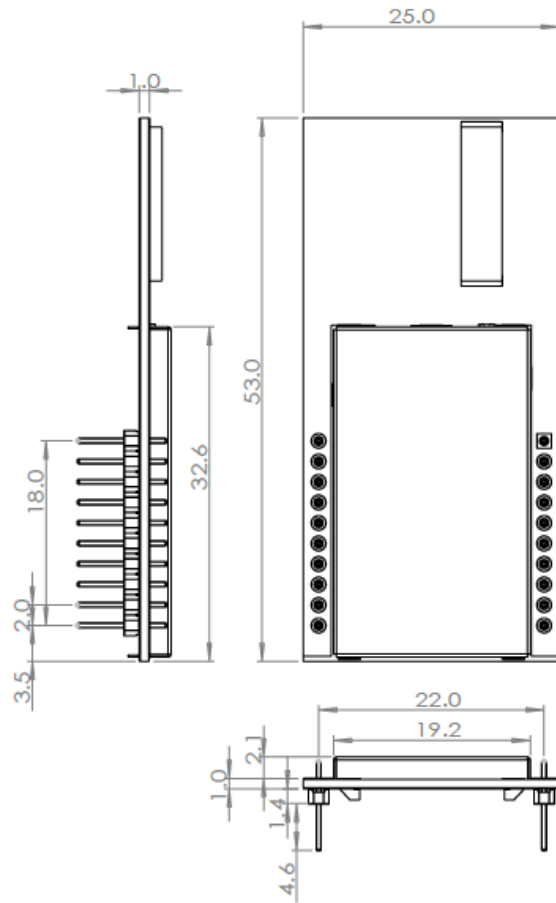

### Trademarks

The information in this document is being provided in connection with Vizmonet products, which are subject to continuous developments and improvements. While every effort is made to ensure that the information contained in this document is correct and accurate at the time of this printing, Vizmonet makes no representations or warranties with respect to the accuracy of the information and is not liable for errors or mistakes that may arise. However, Vizmonet reserves the right to make changes to specifications and product descriptions at any time without notice. Vizmonet does not assume any responsibility for the use of the described product; neither does it convey any license under its patent rights, or the rights of others. Vizmonet products are not intended, authorized, or warranted for use as components in applications intended to support or sustain life. Built-to-Customize™ is a trademark of Vizmonet. All other trademarks, registered trademarks and product names are the sole property of their respective owners.

**Contact**  
Web: [www.vizmonet.com](http://www.vizmonet.com)  
Email: [enquiry@vizmonet.com](mailto:enquiry@vizmonet.com)

**Headquarters**  
Vizmonet Pte Ltd  
21, Woodlands Close  
#03-01, Primz Biz Hub  
Singapore 737 854

HW REV# 02.00